

Please type a plus sign (+) inside this box →

02 - 30

PTO/SB/05 (4/98)

Approved for use through 09/30/00. OMB 0651-0032

Patent and Trademark Office: U.S. DEPARTMENT OF COMMERCE

Under the Paperwork Reduction Act of 1995, no persons are required to respond to a collection of information unless it displays a valid OMB control number

05/26/00

UTILITY PATENT APPLICATION TRANSMITTAL <small>(Only for new nonprovisional applications under 37 CFR 1.53(b))</small>	Attorney Docket No.	17882-733	Total Pages	38
	First Inventor or Application Identifier	Richard Wisniewski		
	Title	Enhanced Thawing of Biopharmaceutical Solutions Using Oscillatory Motion		
	Express Mail Label No.	EL341842940US		

APPLICATION ELEMENTS <i>See MPEP chapter 600 concerning utility patent application contents.</i>	ADDRESS TO: Assistant Commissioner for Patents Box Patent Application Washington, DC 20231
--	--

1. Fee Transmittal Form (e.g., PTO/SB/17)
(Submit an original, and a duplicate for fee processing)
2. Specification *[Total Pages 22]*
(preferred arrangement set forth below)
 - Descriptive title of the Invention
 - Cross References to Related Applications
 - Statement Regarding Fed-Sponsored R&D
 - Reference to Microfiche Appendix
 - Background of the Invention
 - Brief Summary of the Invention
 - Brief Detailed Description of the Drawings
 - Detailed Description
 - Claim(s)
 - Abstract of the Disclosure
3. Drawing(s) (37CFR 1.152) *[Total Sheets 8]*
4. Oath or Declaration *[Total Pages 2]*
 - a. Newly executed (original or copy)
 - b. Copy from a prior application (37 CFR 1.63(d))
(for continuation/divisional with Box 17 completed)
 - i. **DELETION OF INVENTOR(S)**
Signed statement attached deleting inventor(s) named in the prior application, see 37 CFR 1.63(d)(2) and 1.33(b).

5. Microfiche Computer Program (*Appendix*)
6. Nucleotide and/or Amino Acid Sequence Submission
(if applicable, all necessary)
 - a. Computer Readable Copy
 - b. Paper Copy (identical to computer copy)
 - c. Statement verifying identity of above copies

ACCOMPANYING APPLICATION PARTS	
7. <input checked="" type="checkbox"/> Assignment Papers (cover sheet & document(s))	
8. <input type="checkbox"/> 37 CFR 3.73(b) Statement	<input type="checkbox"/> Power of Attorney <i>(when there is an assignee)</i>
9. <input type="checkbox"/> English Translation Document <i>(if applicable)</i>	
10. <input type="checkbox"/> Information Disclosure Statement (IDS) PTO-1449	<input type="checkbox"/> Copies of IDS Citations
11. <input type="checkbox"/> Preliminary Amendment	
12. <input checked="" type="checkbox"/> Return Receipt Postcard (MPEP 503) <i>(Should be specifically itemized)</i>	
13. <input type="checkbox"/> Small Entity Statement(s)	<input type="checkbox"/> Statement filed in prior application, Status still proper and desired
14. <input type="checkbox"/> Certified Copy of Priority Document(s) <i>(if foreign priority is claimed)</i>	
15. <input checked="" type="checkbox"/> Other: <u>Power of Attorney by Assignee to Exclusion of Inventor</u>	

*NOTE FOR ITEMS 1 & 13, IN ORDER TO BE ENTITLED TO PAY SMALL ENTITY FEES, A SMALL ENTITY STATEMENT IS REQUIRED (37 C.F.R. § 1.27), EXCEPT IF ONE FILED IN A PRIOR APPLICATION IS RELIED UPON (37 C.F.R. § 1.28).

16. If a **CONTINUING APPLICATION**, check appropriate box and supply the requisite information below and in a preliminary amendment:

Continuation Divisional Continuation-in-part (CIP) of prior application No. ___/___

Prior application information: Examiner _____ Group/Art Unit. _____

For CONTINUATION or DIVISIONAL APPS only: The entire disclosure of the prior application, from which an oath or declaration is supplied under Box 4b, is considered a part of the disclosure of the accompanying continuation or divisional application and is hereby incorporated by reference. The incorporation can only be relied upon when a portion has been inadvertently omitted from the submitted application parts.

17. CORRESPONDENCE ADDRESS

Customer Number or Bar Code Label 021971 or Correspondence address below

(Insert Customer No. or Attach bar code label here)

NAME			
ADDRESS			
CITY	STATE	ZIP CODE	
COUNTRY	TELEPHONE	FAX	

Name (Print/Type)	David J. Abraham	Registration No. (Attorney/Agent)	39,554
Signature		Date	May 25, 2000

Burden Hour Statement: This form is estimated to take 0.2 hours to complete. Time will vary depending upon the needs of the individual case. Any comments on the amount of time you are required to complete this form should be sent to the Chief Information Officer, Patent and Trademark Office, Washington, DC 20231. DO NOT SEND FEES OR COMPLETED FORMS TO THIS ADDRESS. SEND TO: Assistant Commissioner for Patents, Washington, DC 20231.

5

Enhanced Thawing of Biopharmaceutical Solutions Using Oscillatory Motion

Inventor:

Richard Wisniewski

10

REFERENCE TO RELATED APPLICATIONS:

This application claims priority to U.S. Patent Application serial number 60/136,708, filed May 28, 1999.

BACKGROUND OF THE INVENTION:

15 Field of the Invention:

This invention relates to thawing of biopharmaceutical solutions, more particularly this invention relates to enhanced thawing of biopharmaceutical solutions using oscillatory motion.

Description of Related Art:

20 Freezing and thawing of biological materials, particularly in the form of biopharmaceutical solutions, are useful as an intermediary processing steps during production operations, or for preservation. Until now only small individual quantities of materials, or solutions, have been successfully processed. These quantities may be contained in vials, straws, test tubes, bottles, bags, pouches, trays, etc. However, the
25 materials handling costs, possibility of small container mix-ups, and dangers of contamination during processing and handling such small quantities meant that freezing and thawing processes were disfavored unit operations. Processing larger individual

5 quantities would reduce or eliminate the handling or contamination problems, but such processing has met with very limited success.

A significant contributor to the final product quality is the thawing step. However, in conventional techniques, the thawing time is undesirably long. In fact, lengthy thawing times, combined with layering and cryoconcentration effects during freezing,
10 leads to significant product degradation. While in small individual quantities the thawing step could be performed relatively rapidly in a controlled way, the thawing of large individual quantities was plagued by extensive thawing times and product degradation.

Accordingly, what is needed is a method for thawing biopharmaceutical materials, particularly biopharmaceutical solutions, in large quantities, with very good final product
15 quality.

SUMMARY OF THE INVENTION:

In an aspect, the invention relates to methods for thawing frozen biopharmaceutical solutions comprising providing a container that contains a biopharmaceutical solution, at least a portion of the biopharmaceutical solution being
20 frozen, providing an oscillatory driver coupled to the biopharmaceutical solution; providing a heat flux into the biopharmaceutical solution; and inducing oscillatory motion of the biopharmaceutical solution via oscillatory motion of the oscillatory driver to accelerate thawing, compared to motionless thawing, of the portion of the biopharmaceutical solution that is frozen.

25 In another aspect, the invention relates to devices for accelerated thawing of a biopharmaceutical solution comprising a container configured to contain the biopharmaceutical solution, wherein at least a portion of the biopharmaceutical solution is frozen; a heating element, coupled to the container, that provides heat flux into the container; and an oscillatory driver capable of being coupled to the biopharmaceutical
30 solution, for inducing oscillatory motion of the biopharmaceutical solution to accelerate thawing, compared to motionless thawing, of the portion of the biopharmaceutical solution that is frozen.

5 **BRIEF DESCRIPTION OF THE DRAWINGS:**

FIG. 1 shows a side view of a container according to the invention.

FIGS. 2A-B show a cross-sectional view of devices according to the invention.

FIG. 3 shows a cross sectional view of a device according to the invention.

FIG. 4 shows a cross sectional view of a device according to the invention.

10 FIG. 5 shows a cross sectional view of a device according to the invention.

FIG. 6A shows a cross sectional view of device according to the invention.

FIGS. 6B-D show paths of motion tables according to the invention.

FIG. 7 shows an elevation of a device according to the invention.

FIG. 8 shows a cross-sectional view of a device according to the invention.

15 FIGS. 9A-D show various devices according to the invention, together with
embodiments of tracks on which the devices move.

FIGS. 10A-B shows an elevation of a device according to the invention, together
with a representation of the oscillatory motion of the device.

20 FIGS. 11A-L show cross-sections of various containers according to the
invention.

FIGS. 12A-P show overhead elevations of various containers according to the
invention.

FIGS. 13A-H show overhead elevations of various containers according to the
invention.

25 FIGS. 14A-L show overhead elevations of various containers according to the
invention.

5 **DETAILED DESCRIPTION OF THE INVENTION:**

The inventor has unexpectedly discovered that inducing oscillatory motion of a biopharmaceutical solution, at least a portion of which is frozen, accelerates thawing of the biopharmaceutical, compared to motionless thawing.

10 Thawing rates may be accelerated by generation of movement of partially-thawed solid-liquid mixture comprising a biopharmaceutical solution against heat transfer surfaces in a container, preferably a container configured to contain, freeze, and/or thaw a biopharmaceutical solution. This movement may be generated wherein a liquid is moving against the heat transfer surfaces and a solid in the liquid is moving against the liquid and against the heat transfer surfaces. The patterns of liquid and solid movement
15 may or may not be similar (the floating solid mass dynamics inside the vessel may or may not be similar to the liquid mass dynamics). The dynamic movements of liquid and solid versus the container and its internal structures may turbulize the liquid phase, affect the boundary layer at the heat transfer surfaces and at the melting solid surface, and mix the liquid (important for liquid phase homogeneity). As a result, the heat
20 transfer between the heated surfaces and liquid and solid phases of the biopharmaceutical solution is significantly enhanced. Increased heat transfer rate leads to very rapid thawing. Rapid thawing reduces or eliminates product degradation present in conventional, slow thawing, processes.

A structure useful in the practice of this invention is that of L. Quan et al., Effects
25 of Vibration on Ice Contact Melting Within Rectangular Enclosures, Transactions of the ASME **120**:518-520 (May 1998). However, the inventor notes that the Quan document does not disclose use of vibration in the thawing of frozen biopharmaceutical solutions; but only pure ice, which crystallizes and melts differently than complex aqueous solutions, such as biopharmaceutical solutions. Thus the Quan document neither
30 teaches nor suggests the present invention.

Motion of liquid and solid phases can be generated in a variety of ways. An intensive relative motion of melting solid and liquid phases is of interest. Therefore, the dynamics of those two phases is of interest. An intensive mutual motion of these two

5 phases may further enhance the thawing rate by additional surface melting via ablation. For example, movement of internal heat transfer surfaces present in a container that contains a biopharmaceutical solution or material of interest, while the container remains stationary, may provide this intensive mutual motion. Alternatively, this may be accomplished by mutual movement of the vessel and the internal heat transfer surfaces
10 or via movement of the vessel with the internal heat transfer surfaces attached to the vessel. Such an attachment may be rigid (permanent fixing), or elastic (via springs, torsion bars, cables, etc.). In a preferable embodiment, the container is driven and moves, while internal structures, such as internal heat transfer structures, can vibrate or oscillate according to their natural frequency. Thus, the forced movement of the
15 container is combined with the inner heat transfer surfaces dynamics and the dynamic and dampening characteristics of the liquid and solid free phases of the biopharmaceutical solution in the container. In a preferred embodiment, the inner structure(s) vibrates at natural frequency imposing micromotion on the liquid phase. This micromotion is transferred into the solid product through the liquid. A macromotion
20 is imposed upon the container, resulting in mutual movement of liquid and solid phases and their relative movement versus the container walls and internal structures. In such a way the container and the internal heat transfer surfaces move differently (a relative movement is induced) and the liquid and solid phases move in another pattern. This generates high mixing and turbulence rates in the liquid phase and a very high heat
25 transfer coefficient at the heat transfer surfaces and the solid-liquid interface of the melting solid. As a result, the thawing rate is very high.

A system according to the invention is shown in FIG. 1, which shows wheeled container 102 and drivers 104 and 106 inducing oscillatory motion of a biopharmaceutical solution within the wheeled container. FIG. 2A shows finned heat
30 exchanger 202 which is driven around pivot 206 by driver 204. FIG. 2B shows the finned heat exchanger of FIG. 2A in container 208, with pivot 206 and driver 204 as discussed above. FIG. 3 shows container 202 which contains frozen biopharmaceutical portion 204 in contact with liquid biopharmaceutical portion 210, and frozen biopharmaceutical portion 204 being coupled to driver 208 via rod 206. Rod 206 is

5 embedded in frozen biopharmaceutical portion 204. Frozen biopharmaceutical portion 204 may be driven in various directions by driver 208 to induce oscillatory motion.

Another embodiment is shown in FIG. 4, where frozen biopharmaceutical portion 402 is driven in an up-and-down direction 406 or a rotational direction 408 by rod 404. In FIG. 5, frozen biopharmaceutical portion 502, which is in free-floating contact with
10 liquid biopharmaceutical portion 504, is driven by driver 506. Driver 506 sends pressure waves through liquid biopharmaceutical portion 504 to move frozen biopharmaceutical portion 502 with an oscillatory motion. In FIG. 6A, container 602 is coupled to motion table 606. Motion table 606 can be moved, in linear directions, as suggested in FIG. 6B, or in two dimensions, as suggested in FIGS. 6C-D, or even three dimensions. FIG. 7
15 shows container 702, suspended by springs 704, and driven by drivers 706 and 708.

A basic harmonic motion (for instance, a sinusoidal amplitude/frequency pattern) may be used to force the movement of the inventive device or to practice the inventive method. Other types of oscillatory movements also may be applied to take full advantage of the dynamics of the container, its internal structures, and the solid and
20 liquid phases contained by it. The oscillatory motion according to the invention may be disharmonic. For example, the oscillatory motion may be in a form of asymmetrical amplitude/frequency curves (induced, for example, by preprogrammed movement of a driver coupled to the container). The movement pattern may include asymmetrical sinusoidal waves, sinusoidal waves with cut off tops/bottoms or cut sideways. Square or
25 triangular waves (symmetrical or asymmetrical sawtooth wave shape) movement patterns may also be applied. Combinations and variations of the above are also contemplated by the invention. These patterns may have variations in amplitude and frequency, and various combinations of waveforms, wherein each waveform may have differing amplitude and frequency, may be used. For example, a small sine wave may
30 be superimposed over a large sine wave (same with other oscillatory shapes beyond the sine waves – for example, involving shapes as described above). In addition to amplitude and frequency acceleration and deceleration patterns not only the container with the internal structures but also the resulting dynamics (acceleration and deceleration) of the liquid and solid phases are considered. Movement periodicities may

5 be selected given consideration of the container and liquid and solid phase dynamics. Aperiodic oscillatory motions may also be used. For example, a step movement back and forth with varying periods of no motion in between the step movements may be used. Orbital oscillatory motions may also be used in the practice of this invention.

10 An example of oscillatory motion according to the invention may be seen in FIGS. 9A-D. In FIG. 9A, a container 902 moves along a bumpy track, where the bumps 904 are in phase with one another. FIG. 9B shows the bumpy track in elevation, with bumps 904 being in phase. FIG. 9C shows container 906 moving along a bumpy track, where bumps 908 and 910 are out of phase with one another. FIG. 9D shows the bumpy track in elevation, with bumps 908 and 910 being out of phase.

15 The phenomena in the liquid-solid mixture caused by small amplitude, high frequency motion (termed "micromotion") and large amplitude, low frequency motion (termed "macromotion") may be very different. Micromotion frequencies may preferably be greater than 200 Hz, with micromotion amplitudes preferably being less than 3.0 mm. Macromotion frequencies may preferably be 200 Hz or less, with macromotion
20 amplitudes preferably being 3.0 mm or greater. During micromotion, there are small amplitude, high frequency waves in liquid phase reaching the melting surface with the frozen mass remaining steady, while, in macromotion, there is a significant mutual macro movement between the solid and liquid phases.

25 The difference in physical phenomena causes difference in thawing mechanisms. For example, macromotion thawing may result in improved product yield versus micromotion thawings. Micromotion thawing might induce vibration of ice crystals in the frozen product mass in relation to the softening glassy states around the ice crystals. Since the biopharmaceutical or pharmaceutical material may be embedded in those glassy states, the product may be exposed to effects of mechanical and
30 hydrodynamic shear forces. These shear forces can be minimized by selection of the biopharmaceutical solution solutes and their concentration. Low amplitudes and high frequencies can make the ice crystals to vibrate stationary positions, thus minimizing the effect of ice crystal movement on the softened glassy state with embedded product.

5 The waves will be then transferred through the softened glass states with the
corresponding dampening effect of such glassy states. The ice crystals will behave as
almost elastic bodies submerged into the soft, rubbery or viscous substance. The
dampening effect reduces the penetration of waves deeply into the solid substance,
although deeper in the solid where the temperatures are lower, the glassy states are
10 rigid and can transfer waves as solids. Thus after the dampening of waves near the
surface, the waves may travel through the solid rigid body. Such microscopic motion
may disturb the ice matrix at the solid product surface and rapidly release ice crystals
from the softened glassy states containing product. This may lead to a significant
increase in the thawing rate.

15 This is a process significantly different than thawing ice only, as in Quan, where
there are no softened glassy states among the ice crystals near the frozen material
surface. In pure ice the crystals melt because of the liquid phase movement at the solid
ice surface. Here, the movement of ice crystals and the softened glassy state (with the
biopharmaceutical or pharmaceutical material in it) can be carried deeply into the
20 material (depending on the glass transition temperature of the glassy/amorphous state;
for example, if sucrose has the glass transition temperature of -32 C and the center of
the frozen product is at about -45 C with the temperature gradient towards the frozen
mass surface being $45\text{ C}/100\text{ mm}$ then the depth of such softened material (mixture of
the ice crystals and softened glassy states based on sucrose) will be approximately 71
25 mm e.g. majority of the solid material. At such large proportion of softened material
between the ice crystals, the block of solid material may rapidly disintegrate if additional
motion (macromotion) is imposed. This process is unique for this application and
completely different than in the case of the ice thawing where the direct wave effect on
the ice crystals at surface leading to some mechanical movement of ice crystal might
30 only reach to about one crystal diameter in depth.

Macromotion as described does not involve significant deformation of the
softened glassy states near the solid product surface (and not at all deeper inside the
product) and therefore, well protects the biopharmaceutical product (such as for
example, proteins) since there is an absence of mechanical or hydrodynamic shear in

5 the softened glassy between the ice crystals. Macromotion can gently rearrange the ice crystals in the softened glassy states near the thawing solid surface and cause release and melting of ice crystals and dissolution of the glassy states. Therefore, this method is more versatile regarding the number of products, formulations used (types of formulation solutes) and concentration of formulation solutes.

10 A combination of micromotion and macromotion may be used in the practice of the invention. For example, an oscillatory movement may be constructed using a mechanical drive with a cam and a connecting arm with superimposed vibrations using a vibrator (electromagnetic, pneumatic, hydraulic, etc.) attached to the container, its internal structures or its frame. Such an embodiment is illustrated in FIGS. 10A-B. FIG.
15 10A shows container 1002 being driven by driver 1004 with a large amplitude motion in combination with driver 1004 which induces a vibration. The resultant waveform is shown in FIG. 10B. The oscillatory motion may be continuously adjusted to take consideration of change of proportion of solid and liquid phases inside the container (the solid phase mass decreases, while the liquid phase mass increases).

20 For harmonic oscillatory motion, the range of amplitudes and frequency may be sufficiently broad so as to accelerate thawing compared to motionless thawing. In a preferable embodiment, the amplitude may range from about 0.0002 mm to about 10,000 mm, more preferably from about 0.015 mm to about 350 mm, and the frequency preferably from about 0.01 Hz to about 20 Hz, more preferably from about 0.01 Hz to
25 about 155 kHz, still more preferably from about 0.1 Hz to about 1 kHz, and most preferably from about 0.4 Hz to about 40 Hz. These ranges may also cover superimposed harmonic movements. An example of such superimposed harmonic movements comprises an oscillatory motion with frequency of 0.5 Hz and the amplitude of 30 mm with superimposed motion of amplitude of 0.5 mm and frequency of 50 Hz.

30 Very often biopharmaceutical materials and/or solutions contain sensitive biological macromolecules or cell products. The biological macromolecule active product recovery level after the freezing-thawing cycle depends on the thawing rate. Generally, very rapid thawing of very small samples may provide higher yields of the

5 product than slower thawing. The rapid thawing rate is typically of some significance in
recovery of viable biological macromolecules or cells. In many cases, biological
products have a strict upper temperature exposure limitation, meaning that the amount
of heat applied for thawing may have an upper limit, with some safety margin imposed.
For example, the heat transfer surface temperature may be limited to 8° C, 12° C, 18° C,
10 25° C or 37° C depending on type of product. (these being examples only, other
temperatures can be used between 0 C and, say 70 C). Sometimes, even lower
temperatures are required as an upper limit. Such a low temperature of heat transfer
surfaces imposes a limit upon the heat flux during thawing, because the bulk liquid
phase temperature may remain close to 0° C during most of the thawing process. The
15 liquid phase temperature may increase above this level (e.g. 0° C) at the end of thawing
when the solid frozen mass disappears or its volume versus volume of liquid becomes
relatively insignificant. Having the bulk liquid temperature close to 0° C during thawing
is a significant factor in protecting product quality during the thawing time (some
products should be stored in the liquid phase within a temperature ranging between 0° C
20 and 4° C, or up to 8° C). During thawing, the temperature may be close to 0° C in bulk
liquid, but in a boundary layer close to the heat transfer surface the temperature in the
liquid phase would approach the temperature of that surface. During the stationary
thawing there may be some natural convection in the liquid phase, causing some limited
molecular exchange in the boundary layer (product molecules or cells residence time
25 may still be substantial at the elevated temperatures). Such a natural convection may,
however, not sufficiently agitate the liquid phase, therefore no homogenization is
present and product stratification/layering may occur within the liquid volume (for
example, higher product concentration may occur at the bottom). In the case of
biological cells or cellular fragments (product is a suspension), a settling of suspended
30 particles can occur. Inducing an oscillatory motion of the biopharmaceutical solution,
particularly the liquid phase, not only homogenizes and mixes the liquid, but also
turbulizes the boundary layer causing product molecules (or cells) residence time and
exposure to elevated temperature in this layer to be significantly reduced.

Heat may be added to the biopharmaceutical solution in a variety of ways. Heat
35 flux may be indirectly coupled to the biopharmaceutical solution via heating jackets

5 applied to the container. Alternatively, heat flux may be directly coupled to the
biopharmaceutical solution by use of submersion heaters or other submerged heat
transfer surfaces, such as those disclosed in United States Patent Application Nos.
08/895,782; 08/895,777, and 08/895,936, all filed on July 17, 1997. Virtually any source
of heat flux in which the heat flux can be controlled, and which source is suitable for use
10 in biopharmaceutical applications, may be conventionally used in the practice of this
invention.

The lowest permitted temperatures of heat transfer surfaces as mentioned above
also limit the heat transfer driving force, e.g. temperature difference heat transfer wall-
frozen product surface/bulk liquid temperature during thawing. The thawing rate may be
15 increased only by an increase in the heat transfer surface area. The container/vessel
designs as described in United States Patent Application Nos. 08/895,782; 08/895,777,
and 08/895,936, all filed on July 17, 1997, possess such a large surface area of heat
transfer surfaces. These documents, and all other documents cited to herein are
incorporated by reference as if reproduced fully herein. Further increase in heat transfer
20 and resulting increase in the thawing rate may be accomplished by turbulization of the
liquid phase. This may change the heat transfer pattern in the vicinity of the heat
transfer surfaces from a laminar character to a turbulent one. From heat transfer
principles it is known that, at the same temperature difference (limited for thawing of
biological products), the heat transfer rate (heat flux) can be significantly increased by
25 changing from laminar to turbulent patterns. The heat flux increase between the liquid
phase and the heat transfer surface permits an increase of heat flux (container is well
insulated, thus energy balance can be assumed) from the melting solid into the liquid
phase. An increase in the heat flux melting solid-liquid means faster thawing rate, e.g.
faster removal of the layers of the frozen product at the solid-liquid interface. An overall
30 effect is a significant shortening of the thawing time. Oscillatory agitation with internal
structures generates high rates of liquid phase turbulization inside the container. Liquid
phase turbulization may cause more rapid release of ice crystals from the soft glassy
state matrix at the solid mass surface.

5 In certain cases, biopharmaceutical materials and/or solutions may be shear sensitive and/or extensively foam when agitated. The oscillatory movement may be then adjusted to reduce the shear rate, and also wave motion on the liquid surface. Any
internals of the container may also be configured to eliminate liquid flow over the
structures – indeed the structures may contain the liquid and solid phase movements in
10 compartments shaped to not only to enhance the heat transfer but also to reduce shear and foaming.

 Biopharmaceutical solutions according to the invention comprise any conventional biopharmaceutical or pharmaceutical material. In preferable embodiments, biopharmaceutical solutions may comprise biological macromolecules such as
15 proteins/enzymes, peptides, DNA, RNA, amino acids, nucleic acids, growth factors, coagulation factors, antibodies, and the like; biological cells or cell fragments/components, including bacteria, fungi, yeast, single cell organisms, mammalian (particularly human) cells, animal cells, plant cells, organelles, cell membranes, or pieces of tissue and the like; viral materials; organic or inorganic
20 molecules or ions including carbohydrates, antibiotics; or cell growth media. Specific examples include blood and blood products (red and white blood cells, plasma, human serum albumin, etc.), and two or more phase emulsions comprising biological or pharmaceuticals materials. A separate domain comprises the vesicles, liposomes and similar membrane-based entities comprising biological components.

25 The inventive oscillatory motion also may include consideration for relative movement of liquid and the solid (melting) phases. This includes hydrodynamics of the liquid phase and dynamics/hydrodynamics of the floating piece of frozen product. For example, a fin (or fin/baffle) configuration inclined towards a major direction of the oscillatory motion may cause streamlined liquid flow along the fins and an elongated
30 shape of the compartment exposes large side surface areas of the melting mass to this flowing liquid. Location of active heat transfer surfaces at the ends of the elongated compartment may cause formation of larger initial cavities there (more liquid contained there) and the movement of the container causes flow of liquid from cavity to cavity

5 along the fins. In such a way the frozen mass is surrounded by highly turbulent flowing liquid phase, with a concomitant potential increase in thawing rates.

The oscillatory motion according to the invention may be induced in a number of ways, using a number of oscillatory drivers that are coupled to the biopharmaceutical solution. For example, the oscillatory motion may be induced mechanically, such as by
10 an electric motor with a gear box and a cam (that may have various profiles/movement characteristics) with an arm. Alternatively, the oscillatory motion may be induced in a variety of ways, including but not limited to by an electromagnetic solenoid (push/pull), a spring loaded driver (one way movement forced), return by a spring (spring
15 characteristics may vary – linear or nonlinear), a hydraulic drive (motor or cylinder), a pneumatic drive (motor, actuator or cylinder), or a magnetic driver (coupling/decoupling using natural or electro-magnets). The oscillatory drivers may be indirectly coupled to the biopharmaceutical solution through the container or another similar structure, or may be coupled directly to the biopharmaceutical solution, or a combination of indirect and direct coupling may be used.

20 An advantage of a electromagnetic driver is that the operations may be automated: rolling the container in – coupling it magnetically to the drive – processing - decoupling and rolling out. The electromagnetic driver might also be combined with safety features (decoupling if sensors detect someone approaching from a wrong side, etc.). Coupling arms may be rigid or flexible or contain an internal spring/elastic element
25 to affect the movement characteristics and affect the system dynamics. A cable drive may also be applied (cable(s) pulling in both directions alternatively).

Driver characteristics may be further altered by shaping any rollers/wheels (for example, an off-center axis) or rails on which the container moves back and forth. The rails can be slightly curved sideways to add a side motion vector to the main movement
30 or also be vertically curved parallel arches or alternatively located arches to add a vertical or/and sideways component to the major movement. Placing springs/elastic elements (linear or nonlinear) between the container and the rolling frame can further alter the movement characteristics. In a preferable embodiment, end motion elastic

5 bumpers to cause a jolt (shock) at each end of oscillatory movement travel path are installed.

Agitation may be provided to further enhance thawing by enhancing the thermal transfer characteristics of the biopharmaceutical solution subject to oscillatory motion. For example, agitation may be provided by a moving internal heat transfer surface.

10 Alternatively, it may be a rocker moving the solid phase, or it can be an oscillating frame/grid/grate located closely to active (heated) heat transfer surfaces. In another embodiment, agitation may be provided by an array of rods embedded into the frozen blocks close to their centers (last freezing, last melting parts). The array of those rods may then be driven/moved in oscillatory pattern, moving most, if not all, of the frozen
15 portions together within the liquid phase which surrounds them (movement cannot start until sufficient portion of the liquid phase forms). In another embodiment, agitation may be provided in the form of a perforated plate with converging/diverging perforations causing a directional flow of liquid phase. Alternatively, instead of a perforated plate, a frame with "funnels" may be used; oscillatory frame movement would cause directional
20 liquid flow through the funnels. Shaft agitators with paddles at the end could also be used, but the shaft movement instead of being rotational is preferably oscillatory. The paddles and part of the shaft may be embedded in the solid frozen material and move it through the liquid phase. The agitators moving the solid phase in the liquid induce not only a mutual liquid-solid product motion, but also turbulize the liquid around the moving
25 solid and therefore, increase the heat transfer between liquid and heat transfer surfaces, thus cause accelerating thawing.

Internal structures present in the container can combine the tasks of heat transfer enhancement and intensify agitation/mixing during oscillatory motion. For example, internal heat exchangers with fins acting on the principle of thermal bridges formed
30 during freezing, as described in United States Patent Application Nos. 08/895,782; 08/895,777, and 08/895,936, all filed on July 17, 1997, may also act as stationary mixing baffles/barriers to a wavy movement of liquid phase inside the container. Any thermal bridge gaps present will open at the beginning of the warming/thawing process permitting the liquid phase to flow around the fins between the compartments. Such a

5 flow pattern turbulizes the liquid phase near heated surfaces and significantly increases
the heat transfer and as a result the thawing rate. Cross sections of containers having
such internal structures according to the invention are shown in FIGS. 11A-L. Internal
structures may be actively heated (for example through use of a heat exchange fluid or
an electrical resistance heater), be passively thermally conductive (such as a thermally
10 conductive fin), or combinations of the two types of structures. FIGS. 12A- P show top
views of circular cross-sections of inventive containers comprising structures according
to the invention. FIGS. 13A-H show top views of circular cross-sections of inventive
containers comprising structures according to the invention that include both actively
heated structures and passively thermally conductive structures.

15
The effect is further enhanced if there are multiple active heat transfer surfaces
within the container volume with a multiplicity of fins hanging between those heat
transfer surfaces. The baffled structures may be baffles perpendicular to the movement
of the vessel. The baffles may be placed under the angle to the main movement (to
20 cause converging/diverging channels for the dynamically moving liquid phase with the
floating (in aqueous solutions, the frozen material may float due to any density
differences) solid phase. If the solid and liquid move into a converging channel of an
internal structure, at one point the solid mass becomes trapped between converging
structures. Its movement then stops and the relative movement of liquid phase versus
25 that solid phase accelerates. Such an acceleration further turbulizes the boundary layer
at the solid surface, thus increasing heat transfer. In addition, contact heat transfer can
take place between the heat transfer structure and the thawing solid mass. Reversal of
motion (second part of oscillatory movement) may release the solid, which now moves
with the liquid through the diverging channel. Movements of two-phase composition
30 through the diverging-converging channel causes additional relational movement
between the solid and liquid phases causing increase in turbulence, mixing, heat
transfer and resulting increase in the thawing rate.

35 The application of converging and diverging channels within the internal
structures adds another benefit for two-phase hydrodynamics. In the converging

5 channels the liquid may accelerate if there is an outflow at the end of the channel, while
in the diverging channel the liquid phase may decelerate. If there is no outflow, the
converging and diverging channels can increase the static liquid height at the channel
end during converging flow, or lower the liquid level in the diverging flow. Such surface
level differences in the liquid phase cause differences in static liquid pressure and
10 increase the flow of liquid phase through the gaps around the baffles (such as any
thermal bridge openings). A combination of converging and diverging channels can
cause peaks and valleys on the surface of liquid phase to occur on both sides of the
baffle causing a large level difference and liquid flow increase driven by this difference in
static heads of liquid.

15

Internal structures in the container may also be configured to utilize dynamic
pressure (due to the liquid mass motion) of the liquid phase (with the suspended solid
phase) to propel the liquid phase through openings in the baffle or through gaps around
the baffle. Multiple structures can be located "in series" for a better control of the
20 movement of the liquid and solid phases. Heat exchangers with a radial fin
configuration, such as those disclosed in United States Patent Application Nos.
08/895,782; 08/895,777, and 08/895,936, all filed on July 17, 1997, are a variation of
this concept – the fins divide container volume into multiple compartments, with most of
them providing baffling effect across the main direction of oscillatory movement.

25

The internal structures may have special flow-enhancing/directing elements
shaped into them like, for example, converging-diverging nozzles. These elements may
work for all situations and/or all internal structures, e.g. when the container only moves
and the internal structure is fixed to the container, if the internal structure only moves
30 and container is stationary, and when both, the container and the structure move with a
relative motion against each other.

In general, the internal structures may divide the volume of the container, thus
preventing formation of big liquid waves moving from side to side of the whole container.
Any gaps around the internal structures, such as baffles, are beneficial since liquid
35 moves through such gaps with relatively high velocity. The gaps may be located next to

5 active (heated) heat transfer surfaces – particularly if the gaps serve as thermal bridges. The high velocity is turbulized and increases heat transfer rate and as a result, increases the thawing rate.

In a preferable embodiment, the internal structures may direct the liquid flow (due to dynamics caused by the oscillatory motion) at high velocity through areas in a vicinity
10 of active (heated) heat transfer surfaces as well as agitate the bulk liquid volume. The liquid streams may be further directed towards the central part of the volume (compartment) where the floating frozen mass is located. In such a way, the liquid stream passes next to the active heat transfer surface (warms up there) and then is directed through the bulk liquid onto the melting surface passing its enthalpy to this
15 melting surface to be converted into the latent heat of melting. Division of the container volume into compartments, and reducing large amplitude liquid phase waves may reduce splashing and foaming, thereby enhancing final product yields by reducing, for example, biological product denaturation at gas-liquid interfaces.

The oscillatory motion according to the invention may also take the form of
20 rocking/swinging of the container or an internal structure contained within the container. For example the internal structure may be placed on a pivot located in a middle of the container (centrally) or above, or below the center. In another embodiment, the oscillatory motion may be induced by placing the container on a dynamically oscillatorily moving table driven by pre-programmed drive(s) to provide complex motion patterns
25 (adjustable). Such tables may be controlled by accelerometers, and may be driven in multiple axis, etc.

FIGS. 14 A-L show top views of non-circular cross-sections of inventive containers according to the invention. FIGS. 14A-D show top views of non-circular cross-sections of inventive containers without internal structures. FIGS. 14E-L show containers according to the invention that include both actively heated structures and passively thermally conductive structures.

It will be apparent to those skilled in the art that various modifications and variations can be made in the circulators, systems and methods of the present invention

Claims:

What is claimed is:

- 1 1. A method for thawing frozen biopharmaceutical solutions comprising:
 - 2 providing a container that contains a biopharmaceutical solution, at least a
 - 3 portion of the biopharmaceutical solution being frozen,
 - 4 providing an oscillatory driver coupled to the biopharmaceutical solution;
 - 5 providing a heat flux into the biopharmaceutical solution; and
 - 6 inducing oscillatory motion of the biopharmaceutical solution via oscillatory
 - 7 motion of the oscillatory driver to accelerate thawing, compared to motionless thawing,
 - 8 of the portion of the biopharmaceutical solution that is frozen.
- 1 2. The method of claim 1, wherein the oscillatory motion of the oscillatory driver is
- 2 harmonic motion.
- 1 3. The method of claim 1, wherein the oscillatory motion of the oscillatory driver is
- 2 disharmonic motion.
- 1 4. The method of claim 1, wherein an amplitude of the oscillatory motion of the
- 2 oscillatory driver ranges from about from about 0.0002 mm to about 10,000 mm.
- 1 5. The method of claim 2, wherein an amplitude of the oscillatory motion of the
- 2 oscillatory driver ranges from about more preferably from about 0.015 mm to about 350
- 3 mm.
- 1 6. The method of claim 1, wherein a frequency of the oscillatory motion of the
- 2 oscillatory driver ranges from about 0.01 Hz to about 20 GHz.
- 1 7. The method of claim 4, wherein a frequency of the oscillatory motion of the
- 2 oscillatory driver ranges from about 0.1 Hz to about 1 kHz.

1 8. The method of claim 5, wherein a frequency of the oscillatory motion of the
2 oscillatory driver ranges from about 0.4 Hz to about 40 Hz.

1 9. The method of claim 1, wherein the oscillatory motion of the oscillatory driver is
2 induced by inducing oscillatory motion of the container.

1 10. The method of claim 1, wherein the oscillatory motion of the oscillatory driver is
2 induced by inducing oscillatory motion of the portion of the biopharmaceutical solution
3 that is frozen.

1 11. The method of claim 1, wherein the oscillatory motion of the oscillatory driver is
2 induced by inducing oscillatory motion of an unfrozen portion of the biopharmaceutical
3 solution.

1 12. A device for accelerated thawing of a biopharmaceutical solution comprising
2 a container configured to contain the biopharmaceutical solution, wherein at least
3 a portion of the biopharmaceutical solution is frozen;

4 a heating element, coupled to the container, that provides heat flux into the
5 container; and

6 an oscillatory driver capable of being coupled to the biopharmaceutical solution,
7 for inducing oscillatory motion of the biopharmaceutical solution to accelerate thawing,
8 compared to motionless thawing, of the portion of the biopharmaceutical solution that is
9 frozen.

1 13. The device of claim 12, wherein the container comprises a thermal jacket.

1 14. The device of claim 12, wherein the container comprises an agitator.

1 15. The device of claim 12, wherein the oscillatory driver is mechanically coupled to
2 the container.

- 1 16. The device of claim 12, wherein the oscillatory driver is magnetically coupled to
2 the container.
- 1 17. The device of claim 12, wherein the oscillatory driver is coupled to an internal
2 structure, and the internal structure is located internally to the container.

11/15/2011 10:00 AM

Abstract:

Disclosed are methods for thawing frozen biopharmaceutical solutions including providing a container that contains a biopharmaceutical solution, at least a portion of the biopharmaceutical solution being frozen, providing an oscillatory driver coupled to the biopharmaceutical solution; providing a heat flux into the biopharmaceutical solution; and inducing oscillatory motion of the biopharmaceutical solution via oscillatory motion of the oscillatory driver to accelerate thawing, compared to motionless thawing, of the portion of the biopharmaceutical solution that is frozen. Also disclosed are devices for thawing frozen biopharmaceutical solutions.

5

FIG. 1

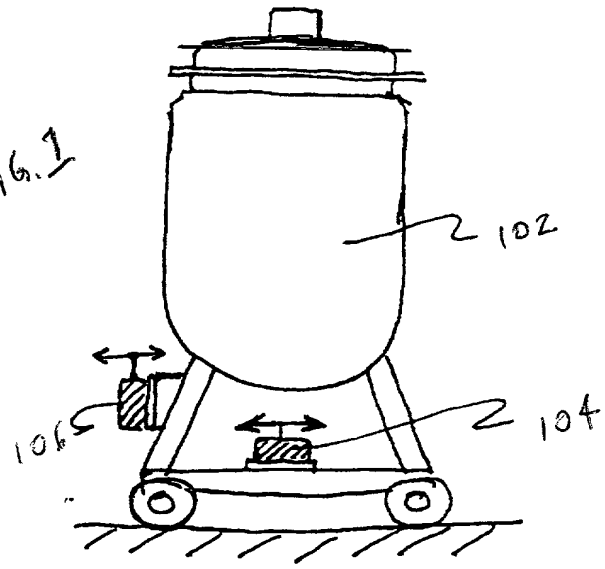

FIG. 2B

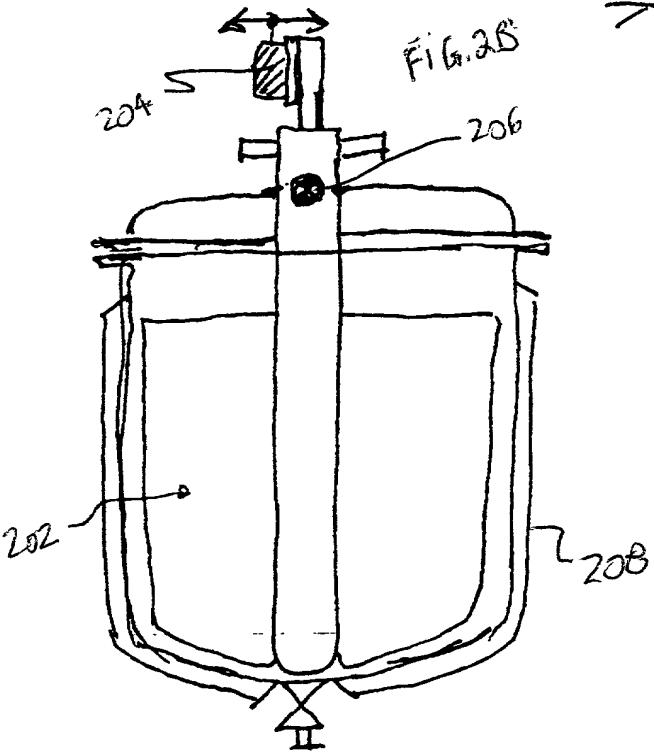

FIG. 2A

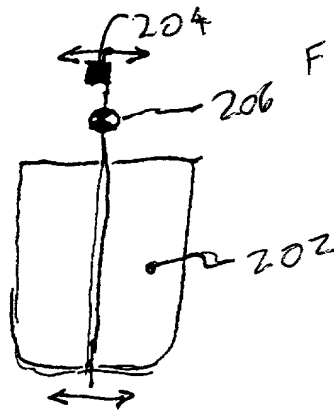
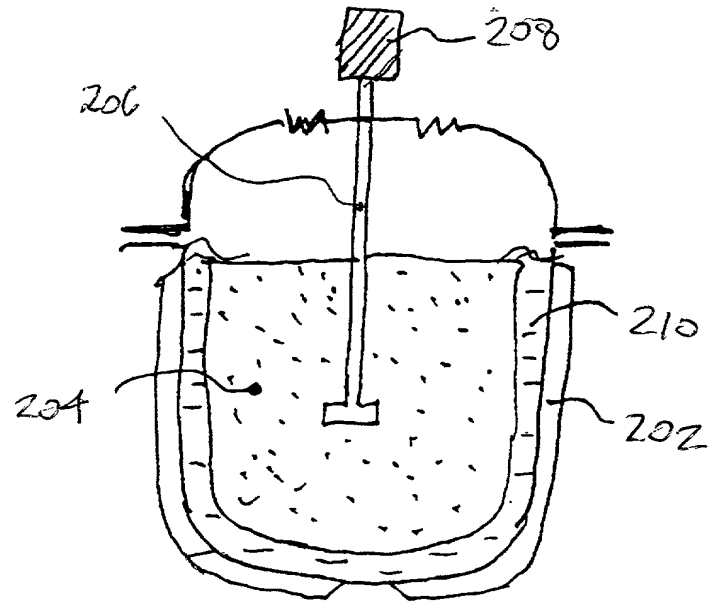

FIG. 3



000000000000000000000000

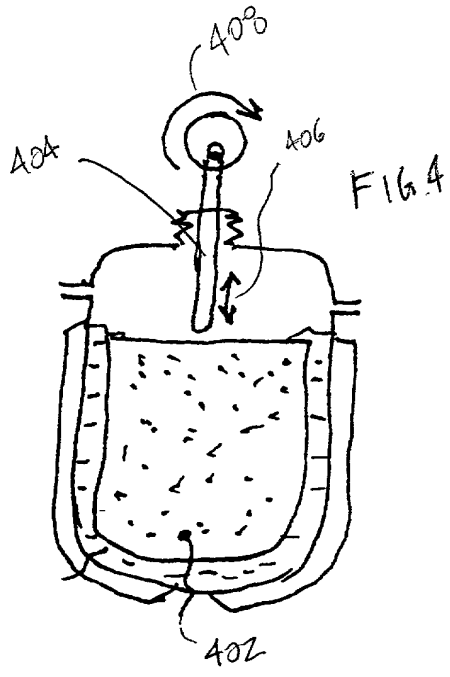

FIG. 5

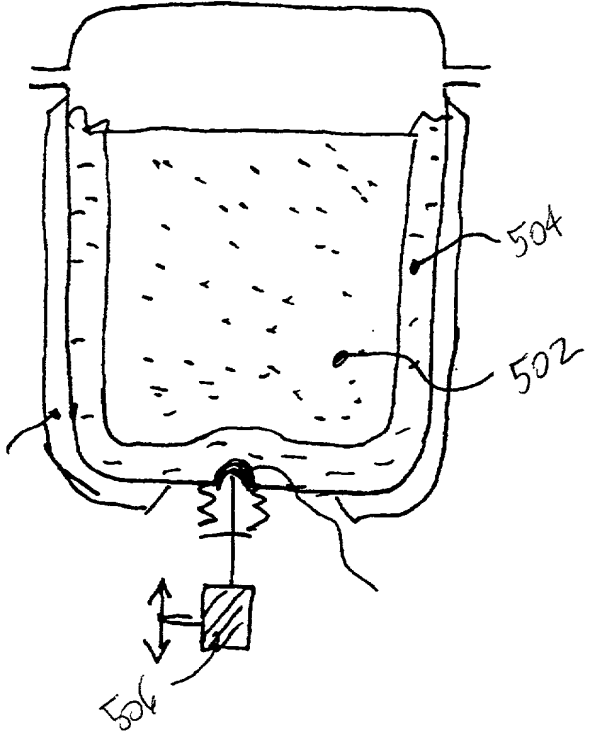

FIG. 6A

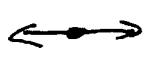
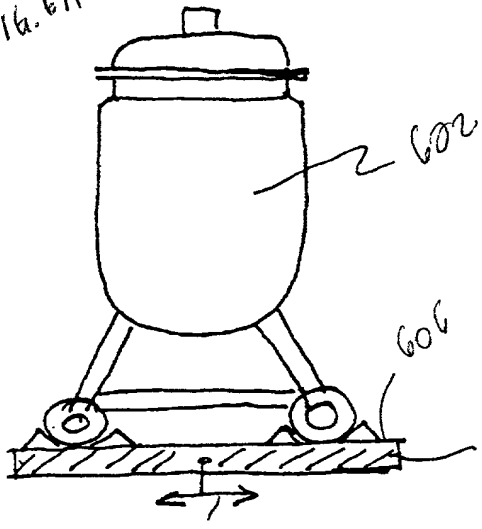

FIG. 6B



FIG. 6C



FIG. 6D

FIG. 7

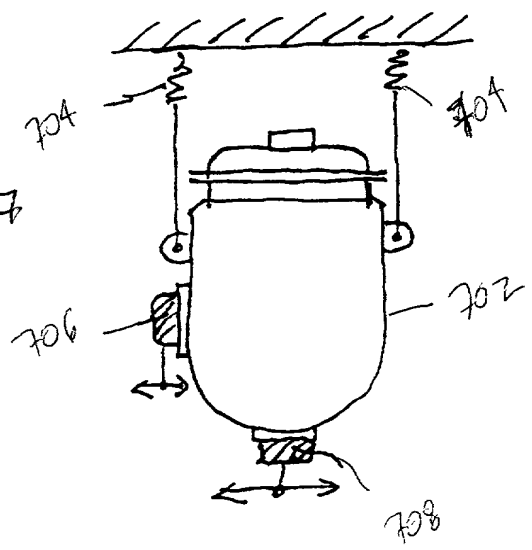

FIG. 8

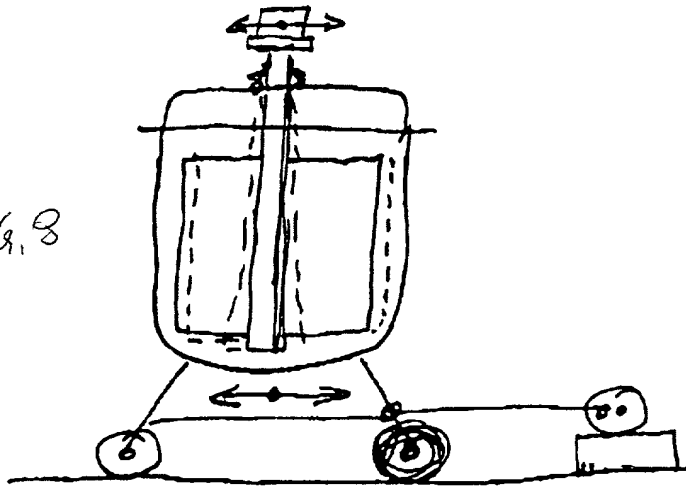

FIG. 9A

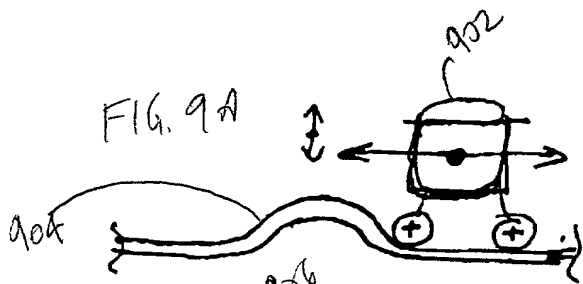

FIG. 9C

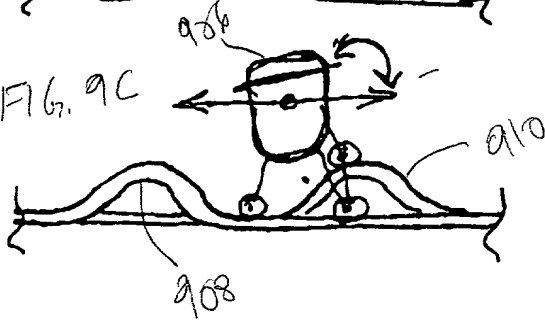

FIG. 9B

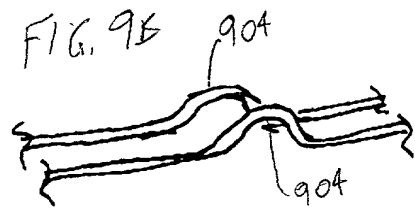

FIG. 9D

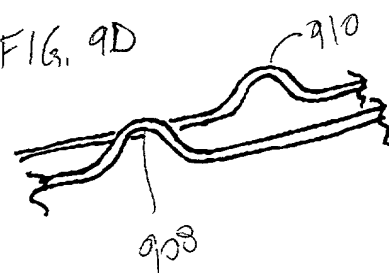

FIG. 10A

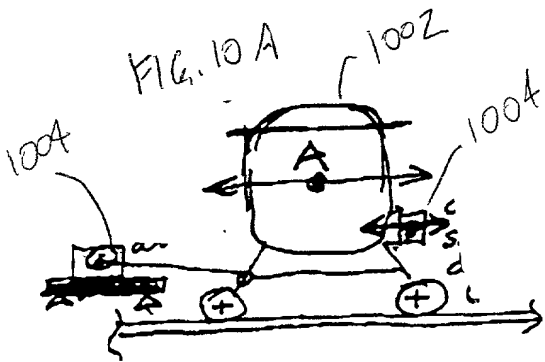
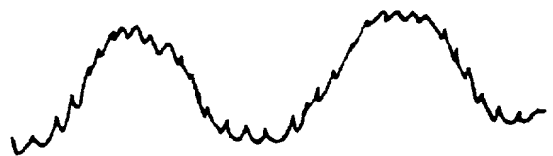

FIG. 10B



www.shutterstock.com

FIG. 11A

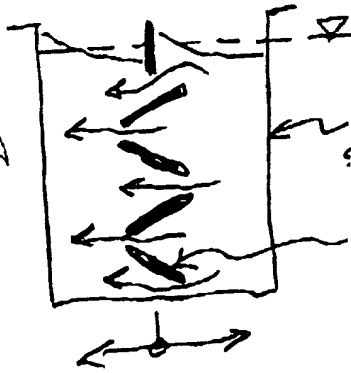

FIG. 11B

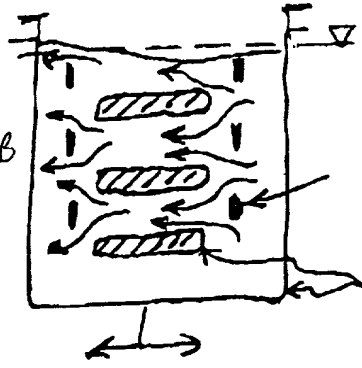

FIG. 11C

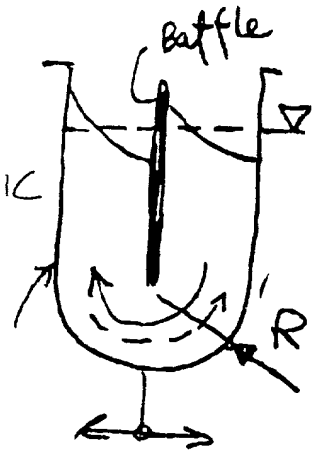

FIG. 11D

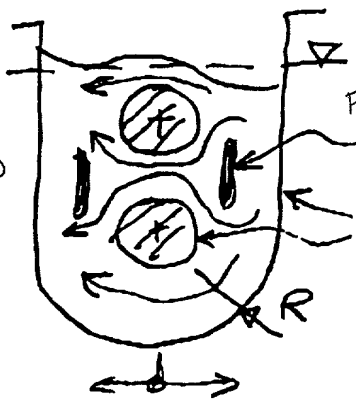

FIG. 11E

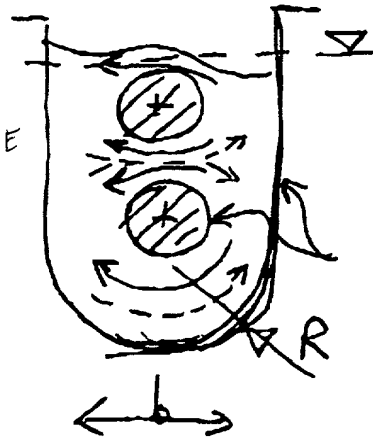

FIG. 11F

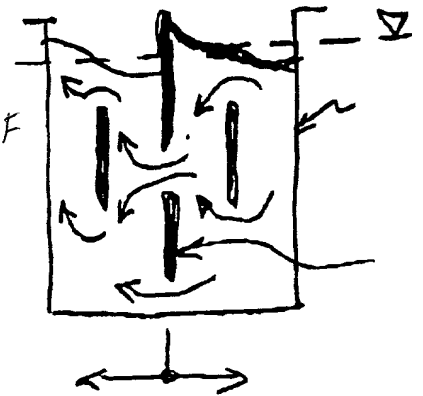

FIG. 11G

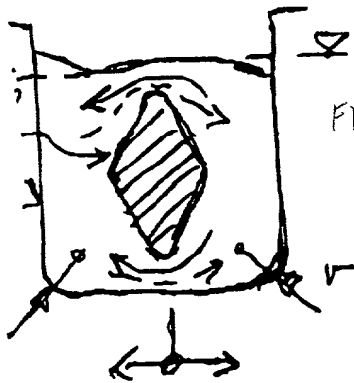

FIG. 11H

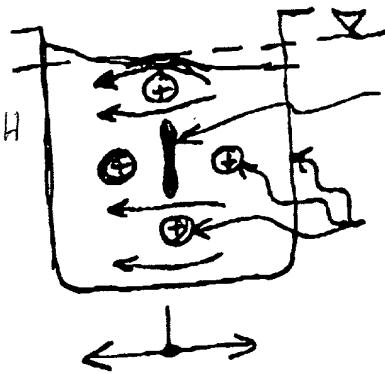

FIG. 11I

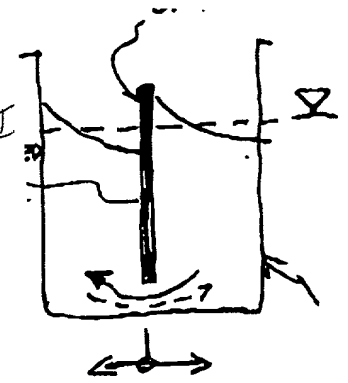

FIG. 11J

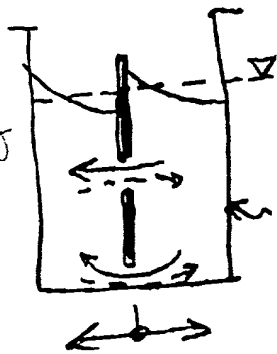

FIG. 11K

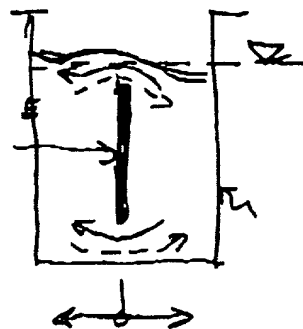

FIG. 11L

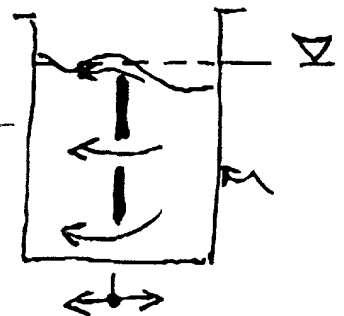

FIG. 12A

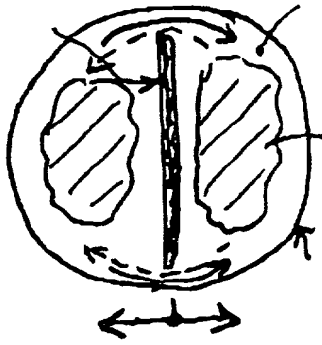

FIG. 12B

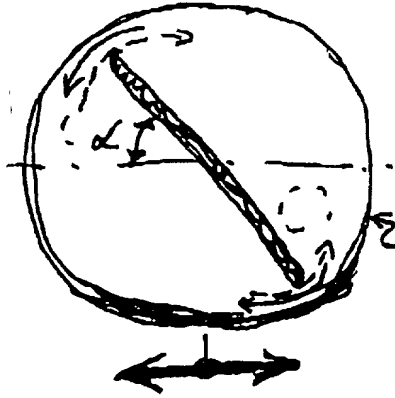

FIG. 12C

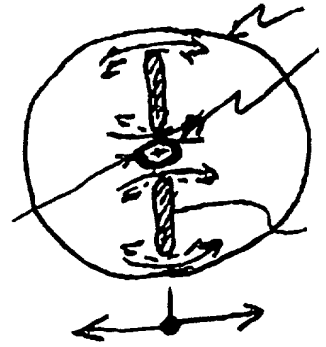

FIG. 12D

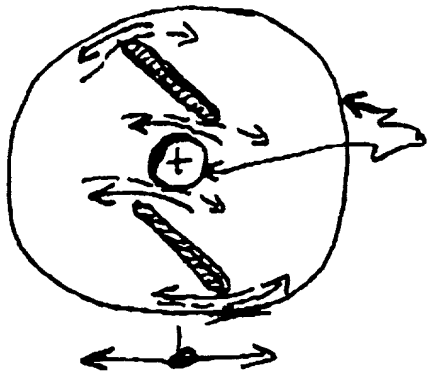

FIG. 12E

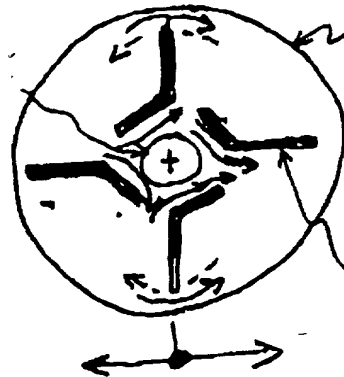

FIG. 12F

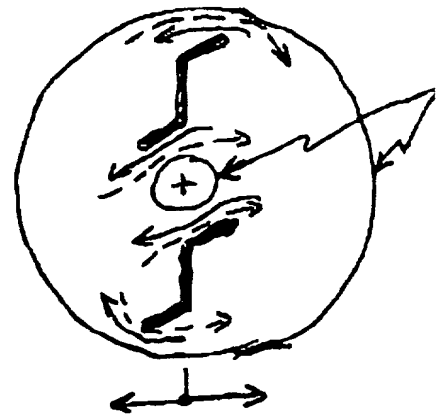

FIG. 12G

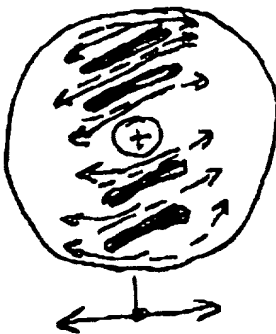

FIG. 12H

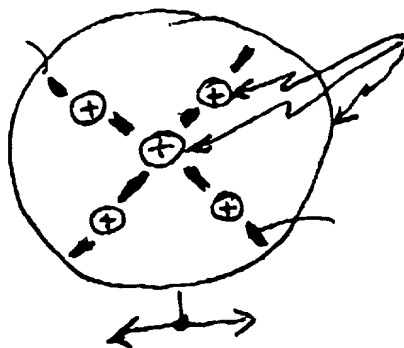
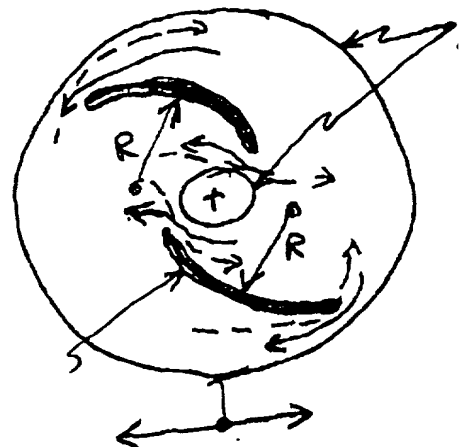

FIG. 12I



00550" 5162200

FIG. 12 J

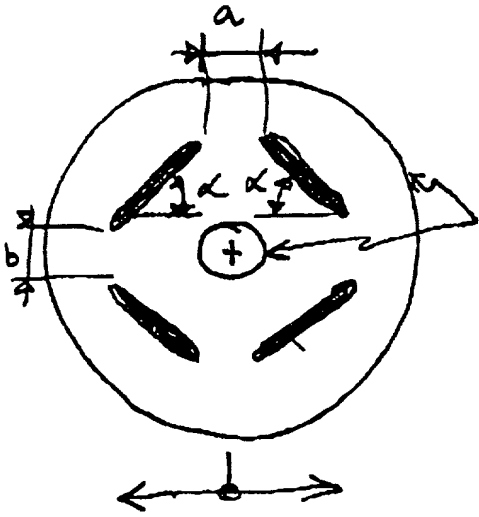

FIG. 12 K

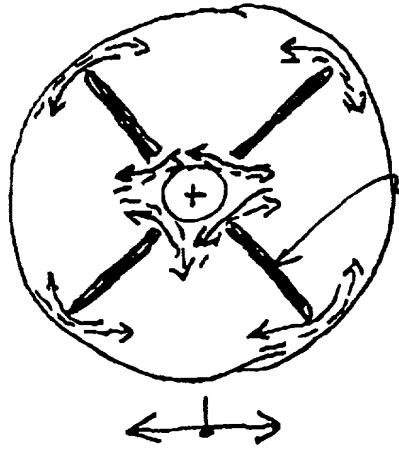

FIG. 12 L

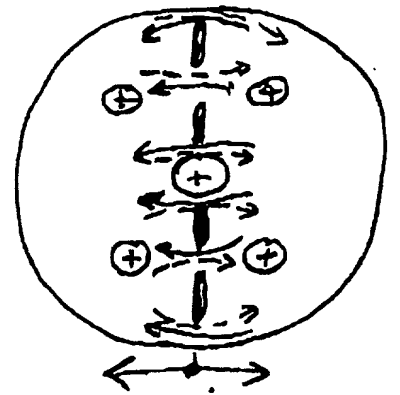

FIG. 12 M

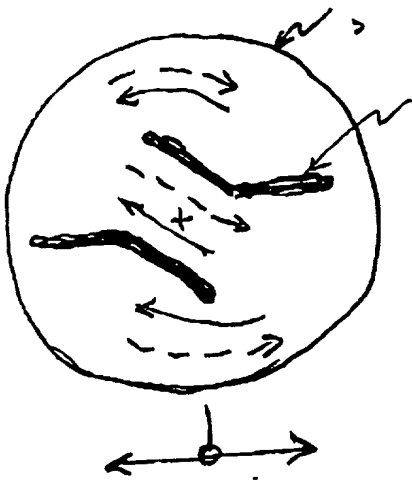

FIG. 12 N

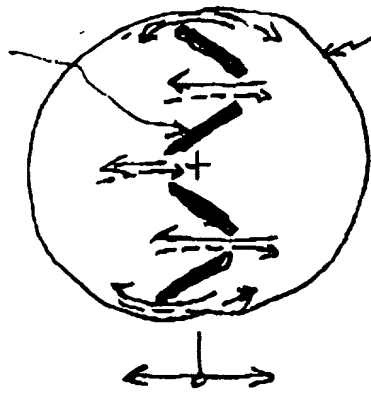

FIG. 12 O

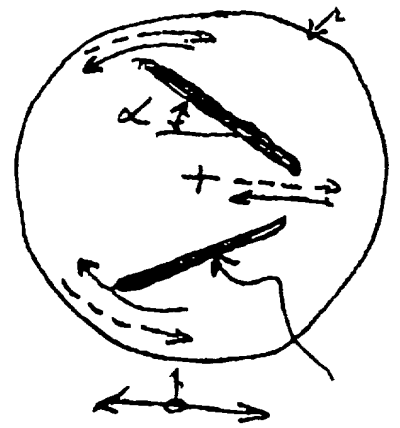

FIG. 12 P

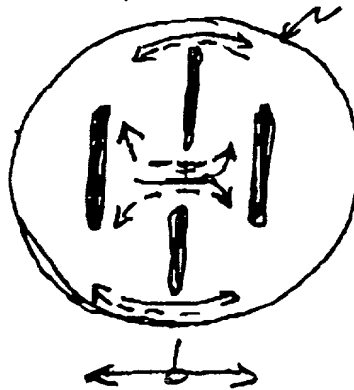

FIG. 13 A



FIG. 13 B



FIG. 13 C

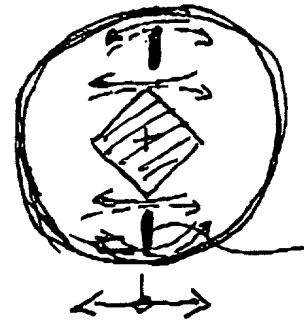

FIG. 13 D

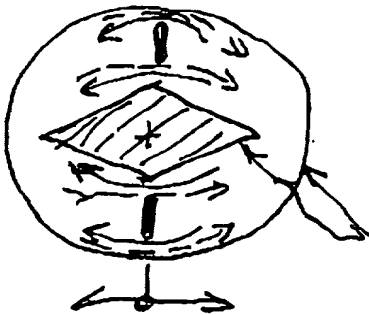

FIG. 13 E

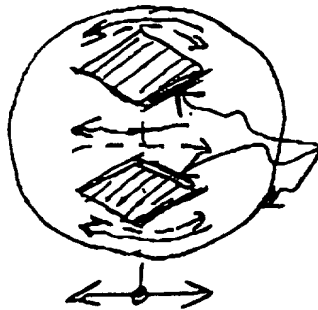

FIG. 13 F

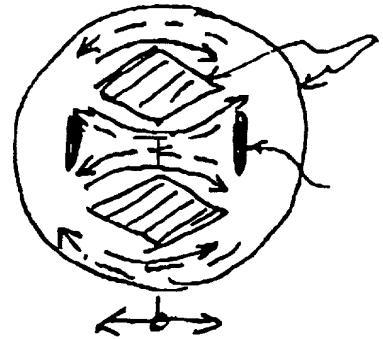

FIG. 13 G

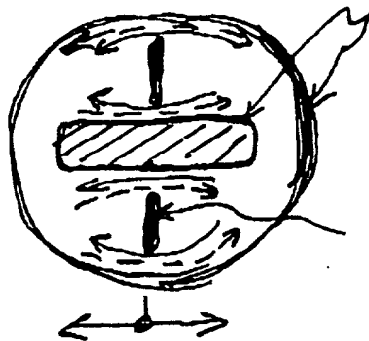

FIG. 13 H



www.ck12.org

FIG. 14A

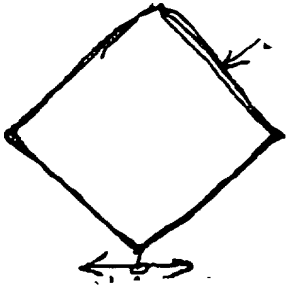

FIG. 14 B

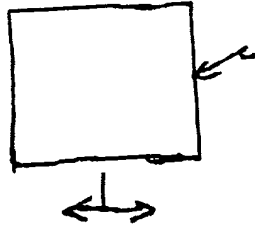

FIG. 14 C

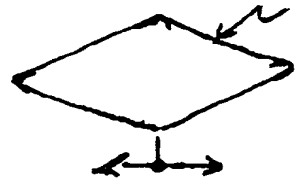

FIG. 14D

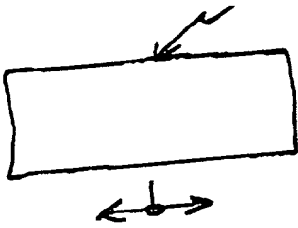

FIG. 14 E

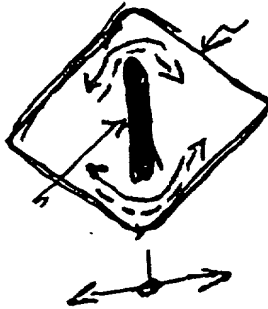

FIG. 14 F

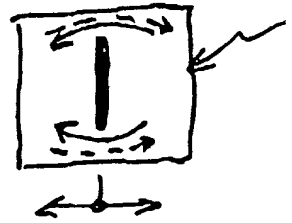

FIG. 14 G



FIG. 14 H



FIG. 14 I

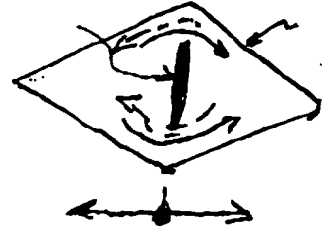

FIG. 14 J

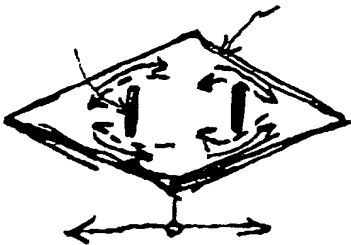

FIG. 14 K

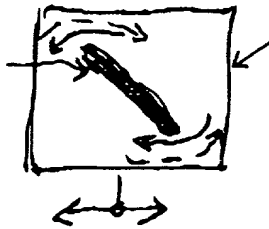
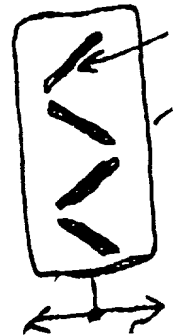

FIG. 14 L



DECLARATION FOR UTILITY PATENT APPLICATION

As a below-named inventor, I hereby declare that:

My residence, post office address and citizenship are as stated below next to my name;

I believe I am the original, first and sole inventor (if only one name is listed below) or an original, first and joint inventor (if plural names are listed below) of the subject matter which is claimed and for which a patent is sought on the invention entitled:

ENHANCED THAWING OF BIOPHARMACEUTICAL SOLUTIONS USING OSCILLATORY MOTION

the specification of which

 X is attached hereto.

_____ was filed on _____ as Application No. _____
and was amended on * _____.
(If Applicable)

I hereby state that I have reviewed and understand the contents of the above-identified specification, including the claims, as amended by any amendment referred to above.

I acknowledge the duty to disclose information which is material to the examination of this application in accordance with Title 37, Code of Federal Regulations, §1.56(a) which states in relevant part: "Each individual associated with the filing and prosecution of a patent application has a duty of candor and good faith in dealing with the Office, which includes a duty to disclose to the Office all information known to that individual to be material to patentability as defined in this section....The duty to disclose all information known to be material to patentability is deemed to be satisfied if all information known to be material to patentability of any claim issued in a patent was cited by the Office or submitted to the Office in the manner prescribed by §§ 1.97(b)-(d) and 1.98."

I hereby claim foreign priority benefits under Title 35, United States Code, §119 of any foreign application(s) for patent or inventor's certificate as indicated below and have also identified below any foreign application for patent or inventor's certificate on this invention having a filing date before that of the application on which priority is claimed:

Prior Foreign Application(s)			<u>Priority Claimed</u>	
_____	_____	_____	Yes	No
(Number)	(Country)	(Day/Month/Year Filed)		
_____	_____	_____	_____	_____

(Number) (Country) (Day/Month/Year Filed) Yes No

I hereby claim the benefit under Title 35, United States Code, §120 of any United States application(s), and under §119(e) of any United States provisional application(s), listed below and, insofar as the subject matter of each of the claims of this application is not disclosed in the prior United States application in the manner provided by the first paragraph of Title 35, United States Code, §112, I acknowledge the duty to disclose material information as defined in Title 37, Code of Federal Regulation, §1.56(a) which occurred between the filing date of the prior application and the national or PCT international filing date of this application:

60/136,708 05/28/99 _____
(Application Serial No.) (Filing Date) (Patented, Pending, Abandoned)

Address all correspondence to:

Paul Davis
Wilson Sonsini Goodrich & Rosati
650 Page Mill Road
Palo Alto, CA 94304

Direct all telephone calls to David J. Abraham at (650) 493-9300.

I hereby declare that all statements made herein of my own knowledge are true and that all statements made on information and belief are believed to be true; and further that these statements were made with the knowledge that willful false statements and the like so made are punishable by fine or imprisonment, or both, under Title 18, United States Code, §1001 and that such willful false statements may jeopardize the validity of the application or any patent issued thereon.

Full name of sole or first inventor: Richard Wisniewski
Inventor's signature: *Richard Wisniewski*
Date: 05/24/00
Citizenship: U.S.A.
Residence: 15 White Plains Ct., San Mateo, CA 94402
Post Office Address: Same as above.

**POWER OF ATTORNEY BY ASSIGNEE TO EXCLUSION OF INVENTOR
UNDER 37 C.F.R. § 3.71 WITH REVOCATION OF PRIOR POWERS**

The undersigned ASSIGNEE of the entire interest in:

- U.S. Patent No. _____
- U.S. application being filed herewith

hereby appoints the following attorneys of Wilson Sonsini Goodrich & Rosati:

Attorney Name	Reg. No.	Attorney Name	Reg. No.
Paul Davis	29,294	John J. Bruckner	35,816
David J. Abraham	39,554	David J. Weitz	38,362
George A. Willman	41,378	U.P. Peter Eng	39,666
Jinntung Su	42,174	Barbara J. Courtney	42,442
Richard L. Gregory	42,607	Van Mahamedi	42,828
Harris, Joel	44,743	Chen, Shirley	44,608
Stephen Warhola	43,237	Mehra, Shaliesh	44,934
Erik L. Oliver	46,296	Michael J. Murphy	37,404
Jonathan T. Manson	43,774		

and all Wilson Sonsini Goodrich & Rosati attorneys registered to practice before the United States Patent and Trademark Office, to prosecute this application and transact all business in the United States Patent and Trademark Office in connection therewith and hereby revokes all prior powers of attorney; said appointment to be to the exclusion of the inventors and the inventors' attorneys in accordance with the provisions of 37 C.F.R. § 3.71.

The following evidentiary documents establish a chain of title from the original owner to the Assignee:

(complete one of the following)

- a copy of an Assignment attached hereto, which Assignment has been (or is herewith) forwarded to the Patent and Trademark Office for recording; or
- the Assignment recorded on ___ at reel ___, frames ___ - ___.

Pursuant to 37 C.F.R. § 3.73(b) the undersigned Assignee hereby states that evidentiary documents have been reviewed and hereby certifies that, to the best of ASSIGNEE's knowledge and belief, title is in the identified ASSIGNEE.

Direct all correspondence and telephone calls to:

Name	David J. Abraham				
Address	Wilson Sonsini Goodrich and Rosati				
Address	650 Page Mill Road				
City	Palo Alto	State	CA	Zip	94304
Country	USA	Telephone	(650) 493-9300	Fax	(650) 493-6811

ASSIGNEE: Integrated Biosystems, Inc.

Name: 
Richard Wisniewski, Chief Technology Officer

Date: May 24, 2000